

[54] BOARD GAME  
 [75] Inventor: William T. Powers, Northbrook, Ill.  
 [73] Assignee: Aladdin Industries, Nashville, Tenn.  
 [22] Filed: Oct. 12, 1972  
 [21] Appl. No.: 296,949

[52] U.S. Cl. .... 273/131 B, 273/136 H, 273/137 R  
 [51] Int. Cl. .... A63f 3/00  
 [58] Field of Search..... 273/131, 137 R, 134

[56] **References Cited**

**UNITED STATES PATENTS**

519,326	5/1894	Davids .....	273/131 K
1,165,688	12/1915	Maris.....	273/131 AB
2,162,876	6/1939	Barton.....	273/131 B
2,585,268	2/1952	Olsen .....	273/131 B
2,732,211	1/1956	Foster.....	273/131 AB
2,847,222	8/1958	Weeks.....	273/137 R X
3,155,391	11/1964	Chittenden.....	273/131 AD
3,309,092	3/1967	Hardesty et al.....	273/134 GA
3,430,960	3/1969	Warman.....	273/131 AB

**OTHER PUBLICATIONS**

Playthings Magazine, May, 1972, p. 40.

Primary Examiner—Anton O. Oechsle  
 Assistant Examiner—Paul E. Shapiro

[57] **ABSTRACT**

A board game comprising a playing board having a flat surface marked in a grid pattern to form discrete areas. A plurality of flat playing tiles, dimensionally corresponding to the discrete areas are placed on the surface of the board by the players along with one start and one home tile for each player. Each playing tile has a different set of direction vectors on its exposed surface so that after the players have placed all the playing tiles on the board surface, a playing surface consisting of the direction vectors is presented. Each player is provided with a transparent playing piece which at the beginning of the game is placed on the player's home tile. Play commences with one player moving his playing piece to a playing tile so that the direction vectors on that playing tile may be viewed through the playing piece. The opponent may then move his playing piece to a playing tile in any of the directions indicated by the vectors so viewed. The other player may then move his playing piece in a similar fashion. Play continues until one of the players moves onto his own home tile at which time that player wins the game.

11 Claims, 13 Drawing Figures

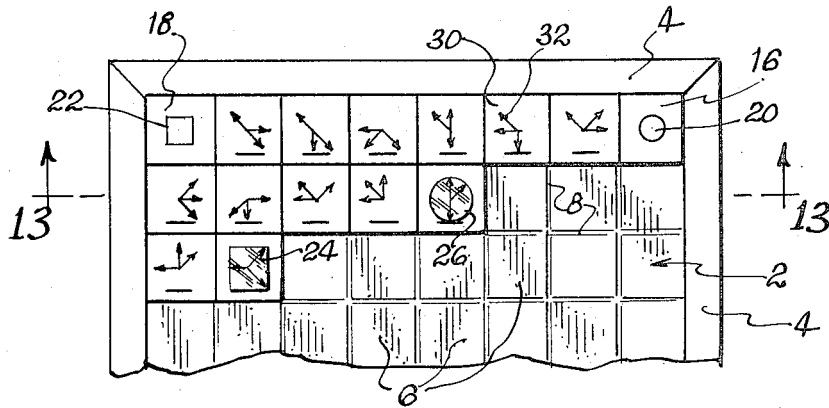

FIG. 1

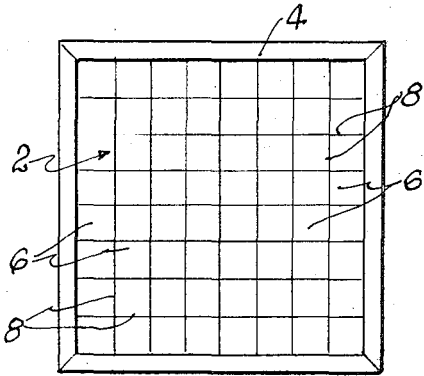

FIG. 2

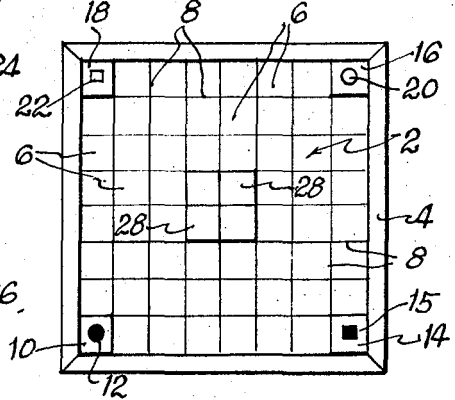

FIG. 3

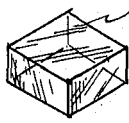

FIG. 4

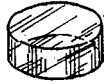

FIG. 5

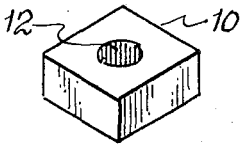

FIG. 6

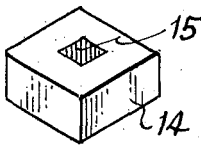

FIG. 7

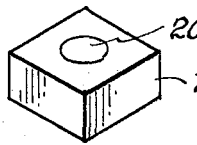

FIG. 8

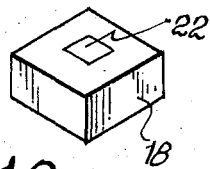

FIG. 9

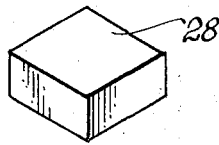

FIG. 10

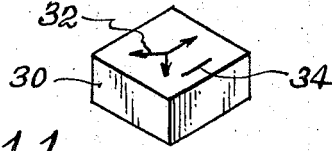

FIG. 11

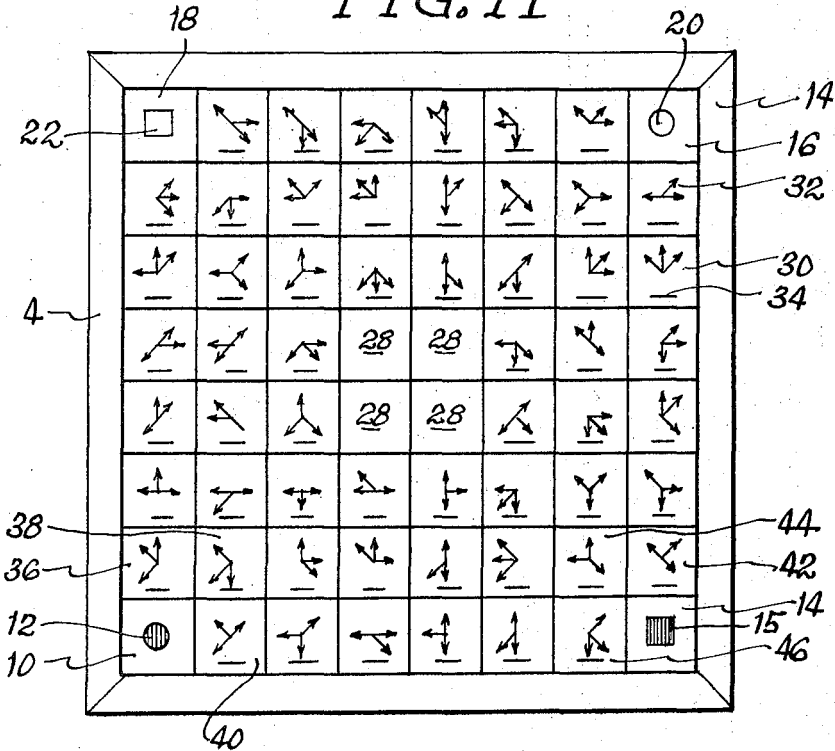

FIG. 12

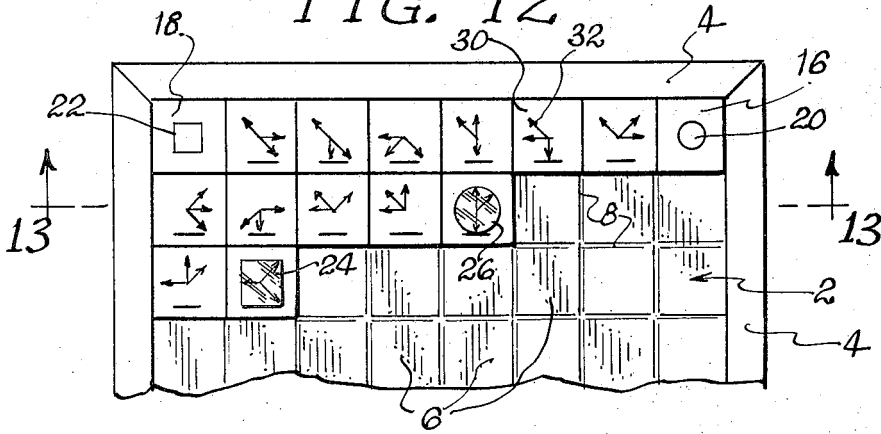
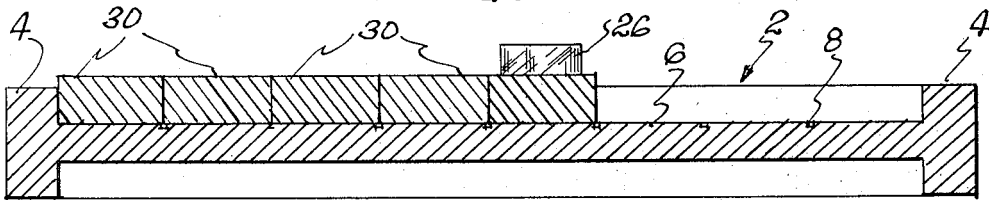

FIG. 13



1  
BOARD GAME

BACKGROUND OF THE INVENTION

This invention relates generally to board games. More specifically, it relates to board games wherein playing pieces are moved from start points to finish points.

Over the years there have been numerous board games proposed and played by people. Generally, they fall into one of two types. A first type is one wherein playing pieces are moved over a board in a somewhat random fashion to get from a start point to a finish point or home point in order to win. The movement in such games is usually dictated by chance, that is, dice are thrown or a pointer is spun to come to rest on a number. The opportunities for strategy in such games are limited. There are variations of such games where some element other than chance is introduced, but in the main the game advances and is won in large part by chance.

There are, of course, other board games wherein playing pieces may be moved in certain paths to capture the pieces of an opponent. Chess and checkers are, of course, examples of such games. These games require that players make their moves in the light of the position of their opponent's pieces. To this extent, there is a kind of feedback or interplay between the two players. However, there is no direct feedback from one player to another in the sense that a move on the part of one player compels his opponent to make a choice of moves from a limited number of possibilities. It is probably so in chess and checkers that the amount of feedback of this nature is directly related to the skill of the players. This has the effect of causing players to lose interest when players of unequal skill are matched.

It is believed, therefore, that it is possible to provide a board game in which the players may find enjoyment in exercising their skill at the game, but in order to achieve that end does not require that the players be of equal skill. That is to say, a board game which does not depend upon chance and wherein there is a feedback, that is, the move of one player dictating to at least a degree the move of another player and wherein the players are given an opportunity to exercise or plan their moves, would provide entertainment for a large number of people spanning a considerable age bracket and skill level.

Therefore, it is an object of this invention to provide a novel board game which does not depend on chance but at the same time can be played by people of varying degrees of skill.

It is another object of this invention to provide a novel board game in which there is a feedback or interaction between the players because the move of one player controls his opponent's moves to a very limited number of possibilities.

SUMMARY OF THE INVENTION

Briefly, the foregoing and other objects of the invention are achieved by providing a playing surface, which is assembled in the initial part of the game by placing a number of direction indicating vectors on a game board. Playing pieces are provided to be moved according to the vectors from a starting place to a finish-

2

ing place as the game proceeds with the player reaching his finishing place first winning.

BRIEF DESCRIPTION OF THE DRAWINGS

The invention itself is set forth in the claims appended hereto and forming a part of this specification. An understanding of an embodiment of the invention may be derived from the detailed description taken in conjunction with the following drawings in which:

FIG. 1 is a plan view of a game board in accordance with the invention prior to the commencement of play;

FIG. 2 is a plan view of the game board at an early stage in the beginning of play;

FIG. 3 is a perspective illustration of a playing piece which may be used with the invention;

FIG. 4 is a perspective illustration of still another playing piece which may be used with the invention;

FIG. 5 is a perspective illustration of a starting tile forming a part of the invention;

FIG. 6 is a perspective illustration of another starting tile forming a part of the invention;

FIG. 7 is a perspective illustration of a finishing or home tile forming a part of the invention;

FIG. 8 is a perspective illustration of another finishing or home tile forming a part of the invention;

FIG. 9 is a perspective illustration of one form of a playing tile forming a part of the invention;

FIG. 10 is a perspective illustration of another playing tile forming a part of the invention;

FIG. 11 is a plan view of a playing board in the form in which it appears after a first phase of the game has been completed with the tiles shown in FIGS. 5 through 10 positioned by the players;

FIG. 12 is a partial plan view of the game board in accordance with the invention showing the positioning of various playing tiles during the first phase of the game; and

FIG. 13 is a sectional view along the line 13—13 of FIG. 12.

DETAILED DESCRIPTION

The game board shown in FIG. 1 is generally constituted by a flat surface on which are provided a plurality of discrete areas. In the particular embodiment illustrated, the game board is formed by a flat surface 2 bounded by upstanding ledges 4 around all sides and, as may be seen, has a rectangular configuration. The board, of course, can be formed of any suitable material, as, for instance, wood, plastic or fiberboard or even metal for that matter. It need not be rigid, in which case, however, it would have to be supported on a rigid flat surface. The upstanding ledges 4 are not necessary but are desirable for they constrain the playing tiles from undesired movement while the game is in progress.

Provided on the flat surface 2 are a plurality of discrete areas 6 formed by marking the flat surface in some fashion. In the illustrated embodiment, this is accomplished by providing vertical and horizontal scoring lines or grooves 8 in the surface of a wooden board. As may be seen, the grooves 8 provide a plurality of discrete areas 6, in this case, sixty-four rectangular such discrete areas.

FIGS. 5 through 10 each illustrated a different type of tile which, in accordance with the contemplated rules of the game, are to be placed on the flat surface

2 in the discrete areas 6. Each one of the tiles is formed as a three-dimensional rectangular element whose length and width correspond approximately to the length and width of any one of the discrete areas. Obviously, the tiles may be formed out of any suitable material.

The first tile 10, that shown in FIG. 5, is intended to be the starting tile of one of the players. A player identification symbol 12 is provided on the top surface of that tile and at the start of the game is placed in one corner of the playing board, as shown in FIG. 2.

FIG. 6 illustrates the starting tile 14 of the other player, and as may be seen, its upper surface is provided with a different player identification symbol 15. At the start of the game, the tile 14 is placed on the same side of the board as is the tile 10 but, as may be seen in FIG. 2, in a corner opposite that of the tile 10. Obviously, the player identification symbols, a circle in the case of 12 and a square in the case of 15, may be varied, but, as will be seen, the use of the circle and square as shown facilitates the actual game playing.

FIGS. 7 and 8, respectively, show a finishing tile 16 corresponding to the starting tile 10 and a finishing tile 18 corresponding to the starting tile 14. The finishing tile 16 is provided with a player identification symbol 20 corresponding to symbol 12 on the tile 10 except that in the case of the symbol 12 it appears as a solid color while the symbol 20 appears as a simple circle in order to distinguish a starting tile from a finishing tile. The finishing tile 18 is likewise provided with a player identification symbol 22 corresponding to the player identification symbol 15. As may be seen in FIGS. 2 and 12, the finishing tiles 16 and 18 may be located on opposite ends of the board from the tiles 10 and 14.

Each player is provided with a playing piece. These are shown in FIGS. 3 and 4. FIG. 3 illustrates a playing piece 24, rectangular in cross section, for one player while FIG. 4 illustrates a playing piece 26, circular in cross section, for the other player. The playing pieces 24 and 26 are formed of any suitable transparent material, preferably plastic, so that when in use the surface of the playing board may be visible from beneath the playing pieces resting thereon. It is to be noted that the shape of the playing piece 24 corresponds to the shape of the player identification symbols 15 and 22 while the shape of the playing piece 26 corresponds to the shape of the player identification symbols 12 and 20.

Shown in FIG. 9 is a blank tile 28 dimensionally approximating one of the discrete areas 6. In a preferred embodiment of the game, four such blank tiles are provided and at the start of the game are placed on the playing board in the center thereof, as shown in FIG. 2. The blank tiles, when so placed, constitute inner borders of the playing area onto which the playing pieces 24 and 26 may not move. It is possible in a variation of the game for the players to locate the blank tiles in any discrete area 6 of the playing surface which they may choose.

The game is completed by the provision of a plurality of rectangular, in this embodiment, playing or vector tiles 30. Each playing or vector tile is provided with three directional indicia or vectors 32 on its upper surface as well as an indicator or marker 34 indicating the bottom of the tile or how it is to be oriented on the playing board.

In the preferred embodiment of the invention, the vectors 32 on each vector tile are different and indicate

three out of a possible eight directions of movement. The eight possible directions are up and down vertically, to the right or left horizontally, and four possible diagonal movements. In the illustrated embodiment of the game, there are fifty-six vector tiles, each, as stated, being different from each other.

With this understanding of the various game elements, the manner in which the game may be played will now be described. As indicated above, it is contemplated that the game will be played in two phases. In the first phase of the game, the start, finish and blank tiles are placed as shown in FIG. 2. The players then, alternating, each take twenty-eight vector tiles. This is done after the players have decided in whatever fashion they choose which is to have the rectangular playing piece 24 and which is to have the circular playing piece 26. The playing pieces are placed on their associated starting tiles 10 or 14.

After the players have each selected twenty-eight vector tiles, depending on which player goes first, they take turns placing the vector tiles on the discrete areas 6 remaining on the flat surface 2. It is contemplated that these may be placed in any empty discrete area. As may be seen in FIGS. 2 and 13, each vector tile is placed with its bottom or alignment indicator similarly oriented so as to insure that when the vector tiles are placed on the flat surface no vector tile will offer the same possibilities of movement as any other vector tile. The first phase of the game is completed when all of the vector tiles have been placed, as shown in FIG. 11. The effect of this is to present a playing surface with start and finish tiles and a plurality of vector tiles over which the playing pieces may be moved.

It is to be noted that even during this first phase of the game the players have an opportunity to exercise strategy or plan. For instance, it would be desirable for one player to place tiles with vectors pointing toward his finishing tile near his opponent's finishing tile for as the game nears an end both players may be near their finishing tiles, and it would be desirable from that player's point of view to have his move possibilities be in the direction of his finishing tile. Another opportunity to exercise strategy or planning is that a player might find it desirable to place vector tiles around his starting tile which would permit his opponent to move only in the direction of his starting tile. Strategy in tile placing can be learned as a player's familiarity with the game increases.

The end result when the first phase of the game is completed is to present a playing board wherein the vector tiles indicate a number of movement possibilities. Each time the game is played a different playing board is presented at the end of the first phase, thus adding interest and variety to the game.

After the vector tiles have been placed, as shown in FIG. 11, the second phase of the game begins. Whichever of the players is entitled to move first moves his playing piece off of his starting tile to one of the adjoining vector tiles. For instance, assuming the player using the circular playing piece 24 is entitled to move first, he may move his playing piece to any one of the vector tiles 36, 38 or 40 bordering on his starting tile 10. When he completes his move, his playing piece is resting on the surface of the selected vector tile and the vectors on the face of that tile may be seen through his playing piece. The vectors so visible then indicate the three directions in which the player's opponent might

move. For instance, if the player using the playing piece 24 moves to the tile 36, the movement possibilities are upward, diagonally upward to the left and diagonally downward to the left when the game is played, as shown in FIG. 11. In this situation, the player using the playing piece 26 may move to either the vector tile 42 or 44 bordering on his starting tile 14. He cannot move to the vector tile 46 because that is not in the direction of one of his permissible moves. Likewise, he cannot move diagonally downward to the left as the edge of the playing board forbids that. Faced with the choices indicated, if the player using the playing piece 26 moves diagonally upward to the left to playing tile 44, he presents his opponent with the choice of moving upward, horizontally to the left or diagonally downward to the right. The opponent then makes his choice of the three possible moves and the game continues with the players alternating moves in their objective to be the first to reach their corresponding finishing tile 16 or 18.

The game thus provides a direct feedback between the movement or decision of one player to his opponent in that the player who has just completed his move presents his opponent with a limited number of possibilities for the following move. The game also provides an opportunity for each player to exercise planning or strategy for as he moves he will want to come as close to his finishing tile as he can while at the same time trying to cause his opponent to move away from the opponent's finishing tile.

The game procedure described above may be considered the basic game for it is possible to have variations. For instance in the first phase of the game the vector tiles may be divided equally between the players and maintained face downwardly until one is picked up to be placed on the flat surface 2. Thus, an element of chance may be introduced into this phase of the game. As indicated above, the blank tiles 28 need not be placed in the center of the board but may be arbitrarily placed by the players just as they placed the vector tiles.

It is contemplated that other variations may be made in the game rules and that variations may be made in the configuration of the game board, the tiles and the playing pieces. Also, variations may be made in the number of vectors on the vector tiles. It is intended by the claims appended hereto and forming a part of this specification to cover all variations which come within their scope.

What is claimed as new and desired to be secured by letters patent is:

1. A game comprising a playing board having a flat surface, said flat surface having a plurality of discrete areas formed thereon, some of said discrete areas being reserved for starting and finishing positions, one starting and finishing position for each player, a plurality of movable playing tiles each with a surface having boundaries substantially corresponding to those of said discrete areas whereby any playing tile may be placed on said flat surface in any discrete area unoccupied by any other playing tile or any discrete area reserved for starting and finishing and when so placed said playing tiles form substantially the entire playing surface of the game, one playing piece for each player for placement on the playing surface formed by said playing tiles and constructed to permit viewing of the surface of any playing tile on which any playing piece is disposed, each playing tile having on its visible surface two or more directional indicia indicating limits on the movements of said playing pieces disposed elsewhere on said playing surface and each set of indicia on any one playing tile being different from the set of indicia on any other playing tile.

2. The game of claim 1 in which said playing board is rectangular and said discrete areas are formed in a rectangular grid pattern.

3. The game of claim 2 wherein said playing tiles are rectangular and each playing tile when placed on said board surface overlies a discrete area.

4. The game of claim 1 wherein each of said playing pieces has a different shape.

5. The game of claim 4 wherein each playing piece is formed from a transparent material so as to permit viewing of the directional indicia on said playing tile surfaces when a playing piece is on a playing tile surface.

6. The game of claim 5, including one start tile and one finishing tile for each player.

7. The game of claim 6 including a plurality of tiles having blank surfaces.

8. The game of claim 7 wherein said board has sides extending above said flat surface.

9. The game of claim 8 wherein said tiles are formed as solid rectangles having a length and width greater than their height.

10. The game of claim 1 wherein said indicia are in the form of directional vectors.

11. The game of claim 10 wherein each playing tile is provided with an orienting indicator thereon.

\* \* \* \* \*

50

55

60

65